

SCREW TYPE Terminal Blocks

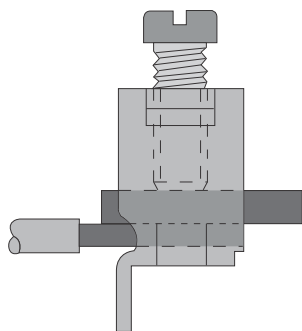

SCREW CONNECTION

Screw type connection is the classical method for terminal blocks. Reinforced clamps ensures the safe and durable connection for the long time usage.

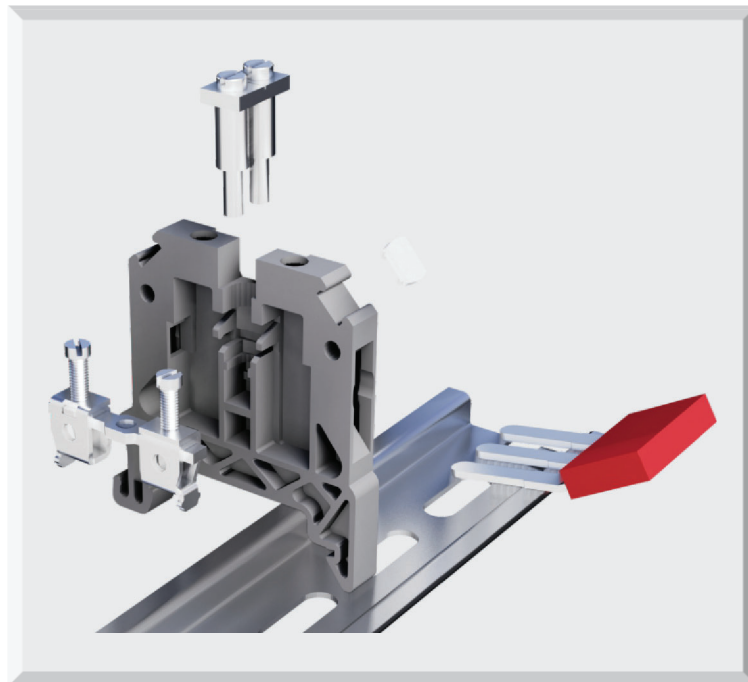
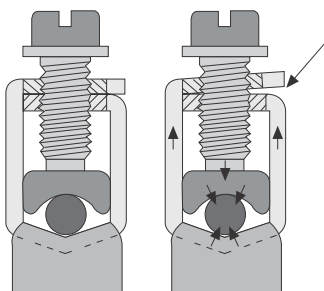

RELIABLE CLAMPING

The connection unit (yokes) in the terminal block is made of reinforced steel, as in the screw. When the screw is tightened, the force that occurs in the connection unit creates a locking mechanism. Thanks to that, durable and safe connection is obtained.

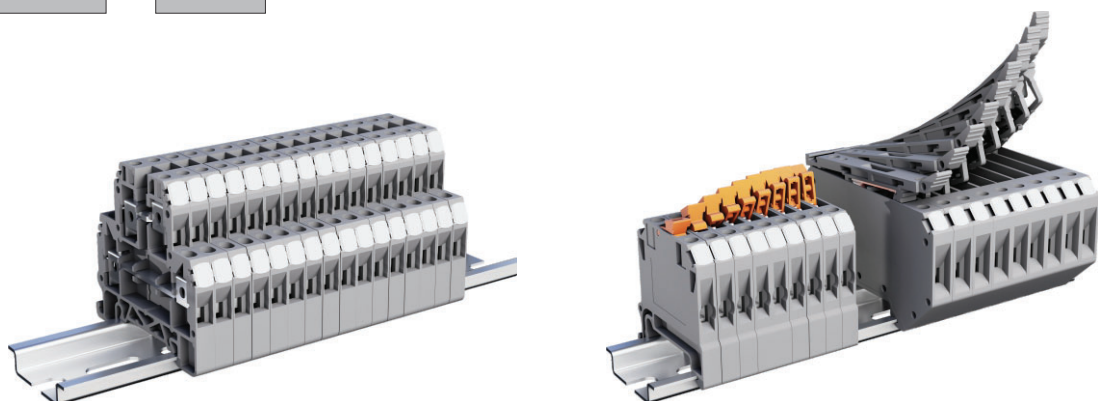

Feed Through Terminal Blocks



Part No.

Rated Cross Section

Technical Data

IEC 60947-7-1

Rated Impulse Voltage

Operating Temperature

Thermoplastic Flammability

Screw Diameter

Tightening Torque

Insulation Stripping Length

End Stopper

End Plate

Cross Connections

2 Pole

3 Pole

10 Pole

Marking Tags



II 2G Ex eb IIC Gb

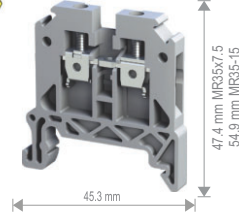

Width: 6 mm
8000099008

Screw Terminal Block

TB1 TBL2,5 Gray

2.5 mm² / AWG 20-12

500 V / 24 A

6 kV

-40°C ... +80°C

Polyamide 6.6 UL94 V-2

M2,5

0.6 Nm

10 mm

TB1 SS2 Gray

TB1 EPL TBL2,5-10

TB1 SCC2,5/2

TB1 SCC2,5/3

TB1 SCC2,5/10

TB1 MTG6 Blank (50 pcs/card)

**Special markings available on request*



II 2G Ex eb IIC Gb

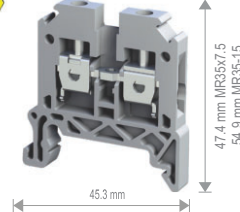

Width: 6.4 mm
8000099028

Screw Terminal Block

TB1 TBL4 Gray

4 mm² / AWG 20-10

800 V / 32 A

6 kV

-40°C ... +80°C

Polyamide 6.6 UL94 V-2

M3

0.8 Nm

12 mm

TB1 SS2 Gray

TB1 EPL TBL2,5-10

TB1 SCC4/2

TB1 SCC4/3

TB1 SCC4/10

TB1 MTG6.4 Blank (50 pcs/card)

**Special markings available on request*



II 2G Ex eb IIC Gb

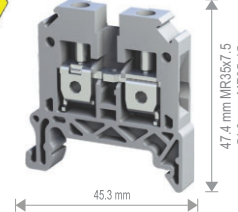

Width: 8 mm
8000099038

Screw Terminal Block

TB1 TBL6 Gray

6 mm² / AWG 20-8

800 V / 41 A

8 kV

-40°C ... +80°C

Polyamide 6.6 UL94 V-2

M3.5

1.2 Nm

12 mm

TB1 SS2 Gray

TB1 EPL TBL2,5-10

TB1 SCC6/2

TB1 SCC6/3

TB1 SCC6/10

TB1 MTG8 Blank (50 pcs/card)

**Special markings available on request*

Feed Through Terminal Blocks



Part No.

Rated Cross Section

Technical Data

IEC 60947-7-1

Rated Impulse Voltage

Operating Temperature

Thermoplastic Flammability

Screw Diameter

Tightening Torque

Insulation Stripping Length

End Stopper

End Plate

Cross Connections

2 Pole

3 Pole

10 Pole

Marking Tags



II 2G Ex eb IIC Gb

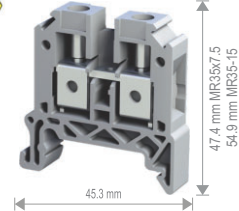

Width: 10 mm
8000099048

Screw Terminal Block

TB1 TBL10 Gray

10 mm² / AWG 20-6

800 V / 57 A

8 kV

-40°C ... +80°C

Polyamide 6.6 UL94 V-2

M4

1.5 Nm

12 mm

TB1 SS2 Gray

TB1 EPL TBL2,5-10

TB1 SCC10/2

TB1 SCC10/3

TB1 SCC10/10

TB1 MTG10 Blank (50 pcs/card)

**Special markings available on request*



II 2G Ex eb IIC Gb

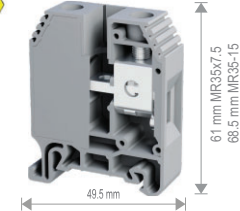

Width: 12.5 mm
8000099058

Screw Terminal Block

TB1 TBL16 Gray

16 mm² / AWG 20-6

1000 V / 76 A

8 kV

-40°C ... +80°C

Polyamide 6.6 UL94 V-2

M5

2,5 Nm

12.3 mm

TB1 SS2 Gray

TB1 EPL TBL2,5-10

TB1 SCC16/2

TB1 SCC16/3

TB1 SCC16/10

TB1 MTG10 Blank (50 pcs/card)

**Special markings available on request*



II 2G Ex eb IIC Gb

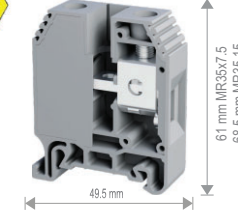

Width: 13.6 mm
8000099068

Screw Terminal Block

TB1 TBL25 Gray

25 mm² / AWG 20-4

1000 V / 101 A

8 kV

-40°C ... +80°C

Polyamide 6.6 UL94 V-2

M5

2,5 Nm

12.3 mm

TB1 SS2 Gray

TB1 EPL TBL2,5-10

TB1 SCC25/2

TB1 SCC25/3

TB1 SCC25/10

TB1 MTG10 Blank (50 pcs/card)

**Special markings available on request*

- Feed Through Terminal Blocks
- High Current Terminal Block



Part No.
Rated Cross Section
Electrical Data
IEC 60947-7-1
Rated Impulse Voltage
Operating Temperature
Thermoplastic Flammability
Screw Diameter
Cable Lug (Min-Max) DIN46235
Tightening Torque
Insulation Stripping Length
End Stopper
End Protective Cover
Cross Connections
2 Pole
3 Pole
10 Pole
Marking Tags

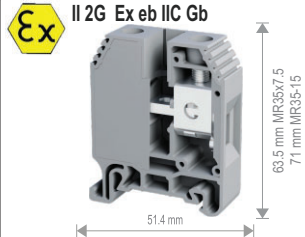

Width: 16.5 mm
8000099078

Screw Terminal Block

TB1 TBL35 Gray
35 mm² / AWG 16-2
1000 V / 125 A
8 kV
-40°C +80°C
Polyamide 6.6 UL94 V-2
M6
3.5 Nm
14.9 mm
TB1 SS2
TB1 C-TBL35-150
TB1 SCC35/2
TB1 SCC35/3
TB1 SCC34/10
TB1 MTG10 Blank (50 pcs/card)
<i>*Special markings available on request</i>



Width: 20.1 mm
8000099088

Screw Terminal Block

TB1 TBL50 Gray
50 mm² / AWG 10-0
1000 V / 150 A
8 kV
-40°C +80°C
Polyamide 6.6 UL94 V-2
M8
8 Nm
19 mm
TB1 SS2
TB1 C-TBL50-150
TB1 SCC50/2
TB1 SCC50/3
TB1 MTG10 Blank (50 pcs/card)
<i>*Special markings available on request</i>

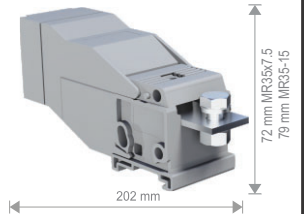

Width: 43.5 mm
800099128

Screw Terminal Block

TB1 TBB70 Gray
70 mm² / AWG 6-2/0
1000 V / 192 A
8 kV
-40°C +80°C
Polyamide 6.6 UL94 V-2
M8
16 - 70 mm ²
15 - 50 Nm
TB1 SS2
TB1 C-TBB70-95-150
TB1 MTG5 Blank (50 pcs/card)
<i>*Special markings available on request</i>

High Current Terminal Blocks



Part No.
Rated Cross Section
Electrical Data
CE (EN 60947-7-1)
VDE (IEC 60947-7-1)
Operating Temperature
Thermoplastic Flammability
Screw Diameter
Cable Lug (Min-Max) DIN46235
Tightening Torque
End Stopper
End Protective Cover
Marking Tags

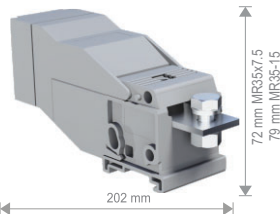

Width: 43.5 mm
8000099138

Screw Terminal Block

TB1 TBB95 Gray
95 mm² / AWG 6-3/0
1000 V / 232 A
8 kV
-40°C +80°C
Polyamide 6.6 UL94 V-2
M10
16 - 95 mm ²
25 - 30 Nm
TB1 SS2
TB1 C-TBB70-95-150
TB1 MTG5 Blank (50 pcs/card)
<i>*Special markings available on request</i>



Width: 43.5 mm
8000099148

Screw Terminal Block

TB1 TBB150 Gray
150 mm² / AWG 4-300 Kcmil
1000 V / 309 A
8 kV
-40°C +80°C
Polyamide 6.6 UL94 V-2
M12
25 - 150 mm ²
25 - 30 Nm
TB1 SS2
TB1 C-TBB70-95-150
TB1 MTG5 Blank (50 pcs/card)
<i>*Special markings available on request</i>

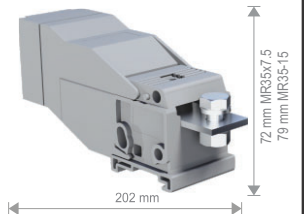

Width: 46 mm
8000099158

Screw Terminal Block

TB1 TBB240 Gray
240 mm² / AWG 0-350 Kcmil
1000 V / 415 A
8 kV
-40°C +80°C
Polyamide 6.6 UL94 V-2
M16
50 - 185 mm ²
30 - 35 Nm
TB1 SS2
TB1 C-TBB240
TB1 MTG5 Blank (50 pcs/card)
<i>*Special markings available on request</i>

Earth Terminal Blocks



Part No.

Rated Cross Section

Technical Data

IEC 60947-7-1

Rated Impulse Voltage

Operating Temperature

Thermoplastic Flammability

Screw Diameter

Tightening Torque

Insulation Stripping Length

End Stopper

End Plate

Marking Tags

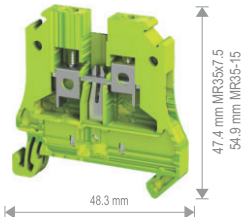

Width: 6 mm
8001099214

Screw Earth Terminal Block

TB1 NTT2,5E

2.5 mm² / AWG 20-12

8 kV

-40°C +80°C

Polyamide 6.6 UL94 V-2

M2,5

0.6 Nm

10 mm

TB1 SS2 Gray

TB1 EPL TBL2,5-10

TB1 MTG6 Blank (50 pcs/card)

**Special markings available on request*

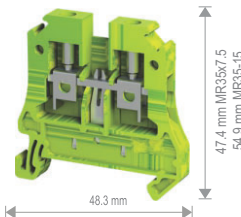

Width: 6.5 mm
8001099224

Screw Earth Terminal Block

TB1 NTT4E

4 mm² / AWG 20-12

8 kV

-40°C +80°C

Polyamide 6.6 UL94 V-2

M3

0.8 Nm

12 mm

TB1 SS2 Gray

TB1 EPL TBL2,5-10

TB1 MTG6.4 Blank (50 pcs/card)

**Special markings available on request*

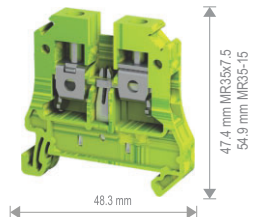

Width: 8 mm
8001099234

Screw Earth Terminal Block

TB1 NTT6E

6 mm² / AWG 20-8

8 kV

-40°C +80°C

Polyamide 6.6 UL94 V-2

M4

1.2 Nm

12 mm

TB1 SS2 Gray

TB1 EPL TBL2,5-10

TB1 MTG8 Blank (50 pcs/card)

**Special markings available on request*

Earth Terminal Blocks



Part No.

Rated Cross Section

Technical Data

IEC 60947-7-1

Rated Impulse Voltage

Operating Temperature

Thermoplastic Flammability

Screw Diameter

Tightening Torque

Insulation Stripping Length

End Stopper

End Plate

Cross Connections

2 Pole

3 Pole

Marking Tags

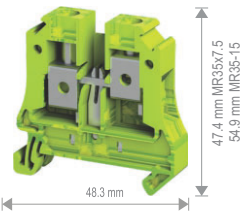

Width: 10 mm
8001099244

Screw Earth Terminal Block

TB1 NTT10E

10 mm² / AWG 20-6

8 kV

-40°C +80°C

Polyamide 6.6 UL94 V-2

M6

1.5 Nm

12 mm

TB1 SS2 Gray

TB1 EPL TBL2,5-10

TB1 MTG10 Blank (50 pcs/card)

**Special markings available on request*

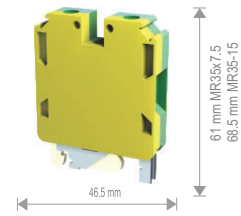

Width: 12.5 mm
8001099194

Screw Earth Terminal Block

TB1 TBL16E

16 mm² / AWG 20-6

8 kV

-40°C +80°C

Polyamide 6.6 UL94 V-2

M5

1.2 Nm

12.3 mm

TB1 SS2 Gray

TB1 SCC 70/2

TB1 SCC 70/3

TB1 MTG10 Blank (50 pcs/card)

**Special markings available on request*

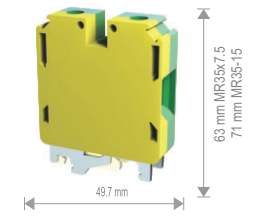

Width: 16.5 mm
8001099204

Screw Earth Terminal Block

TB1 TBL35E

35 mm² / AWG 16-2

8 kV

-40°C +80°C

Polyamide 6.6 UL94 V-2

M6

3.5 Nm

14.9 mm

TB1 SS2 Gray

TB1 SCC 70/2

TB1 SCC 70/3

TB1 MTG10 Blank (50 pcs/card)

**Special markings available on request*

Multilevel Terminal Blocks



Part No.
Rated Cross Section
Electrical Data
IEC 60947-7-1
Rated Impulse Voltage
Operating Temperature
Thermoplastic Flammability
Screw Diameter
Tightening Torque
Insulation Stripping Length
End Stopper
End Plate
Cross Connections
2 Pole
3 Pole
10 Pole
Marking Tags

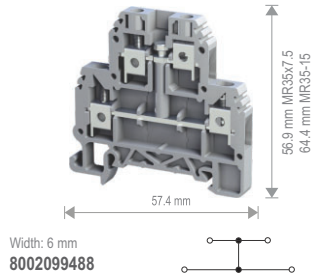

Screw 2x2 Terminal

TB1 TBL2,5-4 2PK
2,5-4 mm² / AWG 20-12
500 V / 32 A
6 kV
-40°C +80°C
Polyamide 6.6 UL94 V-2
M2,5
0.4 Nm
9 mm
TB1 SS2 Gray
TB1 EPL TBL2,5-4 2P
TB1 SCC4/2 TBL4 2P
TB1 SCC4/3 TBL4 2P
TB1 SCC4/10 TBL4 2P
TB1 MTG6 Blank (50 pcs/card)
<i>*Special markings available on request</i>

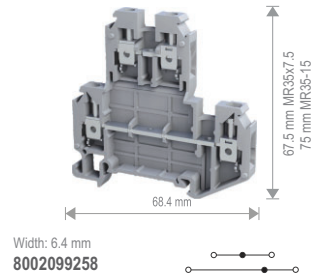

Screw Double Deck Terminal

TB1 TBL4 2P
4 mm² / AWG 20-12
500 V / 32 A
6 kV
-40°C +80°C
Polyamide 6.6 UL94 V-2
M2,5
0.4 Nm
9 mm
TB1 SS2 Gray
TB1 EPL TBL4 2P
TB1 SCC4/2 TBL4 2P
TB1 SCC4/3 TBL4 2P
TB1 SCC4/10 TBL4 2P
TB1 MTG6.4 Blank (50 pcs/card)
<i>*Special markings available on request</i>

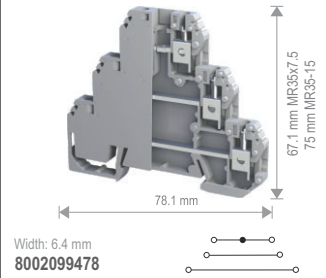

Screw Triple Deck Terminal

TB1 TBL4 3P
4 mm² / AWG 20-12
400 V / 32 A
6 kV
-40°C +80°C
Polyamide 6.6 UL94 V-2
M2,5
0.4 Nm
9 mm
TB1 SS2 Gray
TB1 EPL TBL4 2P
TB1 SCC4/2 TBL4 2P
TB1 SCC4/3 TBL4 2P
TB1 SCC4/10 TBL4 2P
TB1 MTG6.4 Blank (50 pcs/card)
<i>*Special markings available on request</i>

Fuse and Disconnect Terminal Blocks



Part No.
Rated Cross Section
Electrical Data
IEC 60947-7-1
Rated Impulse Voltage
Operating Temperature
Thermoplastic Flammability
Screw Diameter
Tightening Torque
Insulation Stripping Length
End Stopper
End Plate
Cross Connections
2 Pole
3 Pole
10 Pole
Accessories
Marking Tags

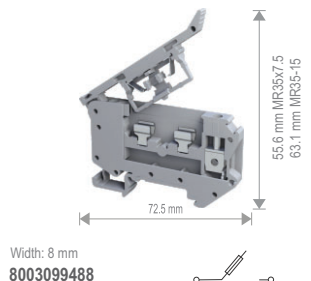

Screw Fuse Terminal

TB1 FDT4
4 mm² / AWG 20-12
800 V / 6.3 A
8 kV
-40°C +80°C
Polyamide 6.6 UL94 V-2
M3
0.5 Nm
12 mm
TB1 SS2 Gray
TB1 TCC6/2
TB1 TCC6/3
TB1 TCC6/10
TB1 FSCB5X20 Fuse Link Copper Bar
TB1 MTG8 Blank (50 pcs/card)
<i>*Special markings available on request</i>

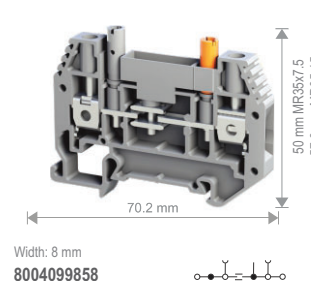

Screw Test & Disconnect

TB1 TDY-C6
6 mm² / AWG 20-8
400 V / 41 A
6 kV
-40°C +80°C
Polyamide 6.6 UL94 V-2
M3.5
0.5 Nm
12 mm
TB1 SS2 Gray
TB1 EPL TDS
TB1 SLC2
TB1 SLC3
TB1 SLC4
TB1 MTG5 Blank (50 pcs/card)
<i>*Special markings available on request</i>